



---

# Asphalt Mixture Automated Testing System with Zero Intervention (AMAZE)

Technical Report 0-6674-03-R1

---

Cooperative Research Program

TEXAS A&M TRANSPORTATION INSTITUTE  
COLLEGE STATION, TEXAS

sponsored by the  
Federal Highway Administration and the  
Texas Department of Transportation  
<https://tti.tamu.edu/documents/0-6674-03-R1.pdf>



|  |  |  |  |  |           |
|--|--|--|--|--|-----------|
| 1. Report No.<br>FHWA/TX-23/0-6674-03-R1   |  | 2. Government Accession No.                          |  | 3. Recipient's Catalog No.   |           |
| 4. Title and Subtitle<br>ASPHALT MIXTURE AUTOMATED TESTING SYSTEM WITH ZERO INTERVENTION (AMAZE)   |  |  |  | 5. Report Date<br>Published: March 2024  |           |
|  |  |  |  | 6. Performing Organization Code  |           |
| 7. Author(s)<br>Fujie Zhou and Jorge Roa   |  |  |  | 8. Performing Organization Report No.<br>Report 0-6674-03-R1                             |           |
| 9. Performing Organization Name and Address<br>Texas A&M Transportation Institute<br>The Texas A&M University System<br>College Station, Texas 77843-3135  |  |  |  | 10. Work Unit No. (TRAIS)  |           |
|  |  |  |  | 11. Contract or Grant No.<br>Project 0-6674-03   |           |
| 12. Sponsoring Agency Name and Address<br>Texas Department of Transportation<br>Research and Technology Implementation Office<br>125 E. 11 <sup>th</sup> Street<br>Austin, Texas 78701-2483  |  |  |  | 13. Type of Report and Period Covered<br>Technical Report:<br>September 2021–August 2023 |           |
|  |  |  |  | 14. Sponsoring Agency Code   |           |
| 15. Supplementary Notes<br>Project sponsored by the Texas Department of Transportation and the Federal Highway Administration.<br>Project Title: Automated Ideal Cracking and Rutting Tests<br>URL: <a href="https://tti.tamu.edu/documents/0-6674-03-R1.pdf">https://tti.tamu.edu/documents/0-6674-03-R1.pdf</a>  |  |  |  |  |           |
| 16. Abstract<br>The Texas Department of Transportation (TxDOT) is currently facing many challenges. Three such challenges in the areas of asphalt pavements and laboratory testing involve (a) cracking and rutting distresses, (b) hiring and retaining employees, and (c) laboratory safety. TxDOT has been addressing the cracking and rutting problems by implementing a balanced mix design method to design durable mixes. However, the lack of workforce and workforce skills hinders such efforts. The primary safety concern in the laboratory is preventing worker injury often associated with the hot asphalt, large masonry saws, high-force testing machines, and toxic chemicals typically found in an asphalt material testing lab. The goal of this project was to employ automation with a robotic arm to alleviate some of these challenges.<br><br>This project developed the <u>A</u> sphalt <u>M</u> ixture <u>A</u> utomated Testing System with <u>Z</u> ero Intervention (AMAZE). AMAZE is able to automatically perform four asphalt mixture tests: (a) bulk specific gravity test, (b) ideal cracking test, (c) ideal rutting test, and (d) indirect tensile strength test. AMAZE has very similar test results as those performed by experienced laboratory technicians. Furthermore, AMAZE with a robotic arm has much better repeatability or consistency than that of laboratory technicians. Deployment of AMAZE makes it possible to measure engineering properties of asphalt mixtures during plant production. Consequently, asphalt mixtures with poor engineering properties can be screened out, resulting in higher-quality and longer-lasting pavements in the field. Additionally, AMAZE test results are objective and without human error, thus allowing it to be used as a reference device. In this way, any potential test result disputes between contractors and TxDOT can be minimized. |  |  |  |  |           |
| 17. Key Words<br>Asphalt Mixture, Performance Tests, Automation, Robot, Air Voids, Ideal Cracking Test, and Ideal Rutting Test   |  |  | 18. Distribution Statement<br>No restrictions. This document is available to the public through NTIS:<br>National Technical Information Service<br>Alexandria, Virginia<br><a href="http://www.ntis.gov">http://www.ntis.gov</a> |  |           |
| 19. Security Classif. (of this report)<br>Unclassified   |  | 20. Security Classif. (of this page)<br>Unclassified |  | 21. No. of Pages<br>52   | 22. Price |



# **ASPHALT MIXTURE AUTOMATED TESTING SYSTEM WITH ZERO INTERVENTION (AMAZE)**

by

Fujie Zhou  
Senior Research Engineer  
Texas A&M Transportation Institute

and

Jorge Roa  
Assistant Research Scientist  
Texas A&M Transportation Institute

Report 0-6674-03-R1  
Project 0-6674-03  
Project Title: Automated Ideal Cracking and Rutting Tests

Sponsored by the  
Texas Department of Transportation  
and the  
Federal Highway Administration

Published: March 2024

TEXAS A&M TRANSPORTATION INSTITUTE  
College Station, Texas 77843-3135



## **DISCLAIMER**

This research was sponsored by the Texas Department of Transportation (TxDOT) and the Federal Highway Administration (FHWA). The contents of this report reflect the views of the authors, who are responsible for the facts and the accuracy of the data presented herein. The contents do not necessarily reflect the official view or policies of FHWA or TxDOT. This report does not constitute a standard, specification, or regulation.

This report is not intended for construction, bidding, or permit purposes. The researcher in charge of the project was Fujie Zhou.

The United States Government and the State of Texas do not endorse products or manufacturers. Trade or manufacturers' names appear herein solely because they are considered essential to the object of this report.

## **ACKNOWLEDGMENTS**

This project was sponsored by TxDOT and FHWA. The authors thank the personnel who contributed to the coordination and accomplishment of the work presented here. Special thanks are extended to Martin Dassi for serving as the project manager. Many people volunteered their time to serve as project advisors, including:

- Enad Mahmoud.
- Travis Patton.
- Melissa Benavides.
- Marta Stephens.



# TABLE OF CONTENTS

|   | <b>Page</b> |
|---|-------------|
| <b>List of Figures</b> .....  | <b>viii</b> |
| <b>List of Tables</b> .....   | <b>ix</b>   |
| <b>Chapter 1. Introduction</b> .....                                    | <b>1</b>    |
| Background.....   | 1           |
| Report Organization.....  | 1           |
| <b>Chapter 2. Conceptualization of Laboratory Test Automation</b> ..... | <b>3</b>    |
| Introduction.....   | 3           |
| Terminology.....  | 3           |
| Concept of Laboratory Test Automation .....                             | 5           |
| Summary .....   | 9           |
| <b>Chapter 3. AMAZE Conceptual Model Development</b> .....              | <b>11</b>   |
| Introduction.....   | 11          |
| Selection of Cracking and Rutting Tests for AMAZE.....                  | 11          |
| AMAZE Conceptual Design.....  | 15          |
| CAD Design for Rapid Cooling Unit.....                                  | 16          |
| CAD Design for Air Void Measurement Unit.....                           | 18          |
| CAD Design for Temperature Conditioning Unit .....                      | 20          |
| CAD Design for Material Testing Unit .....                              | 22          |
| Summary .....   | 22          |
| <b>Chapter 4. AMAZE Actual Realization and Evaluation</b> .....         | <b>23</b>   |
| Introduction.....   | 23          |
| Actual Realization of the AMAZE Conceptual Designs .....                | 23          |
| Actual Realization of Rapid Cooling Unit.....                           | 23          |
| Actual Realization of Air Voids Measurement Unit.....                   | 25          |
| Actual Realization of Temperature Conditioning Unit.....                | 27          |
| Actual Realization of Material Testing Unit.....                        | 28          |
| Actual Realization of Robotic Arm Unit .....                            | 29          |
| Actual AMAZE Device .....   | 29          |
| Evaluation of the Completed AMAZE .....                                 | 30          |
| Summary .....   | 33          |
| <b>Chapter 5. AMAZE Implementation Plan</b> .....                       | <b>35</b>   |
| <b>Chapter 6. Conclusion and Recommendations</b> .....                  | <b>37</b>   |
| Conclusion .....  | 37          |
| Recommendations.....  | 37          |
| <b>References</b> .....   | <b>39</b>   |

## LIST OF FIGURES

|  | <b>Page</b> |
|--|-------------|
| Figure 1. Robot Terminology (Kandray 2010).....  | 4           |
| Figure 2. Automation Concept for Transportation Construction.....                                  | 5           |
| Figure 3. Tiered Process for Laboratory Automation Implementation.....                             | 8           |
| Figure 4. Individual Test Optimization and Interfacing. ....                                       | 9           |
| Figure 5. QC/QA Production Cell Schematic.....   | 15          |
| Figure 6. Potential Implementation of a Laboratory Production Cell. ....                           | 16          |
| Figure 7. Rapid Cooling Concept. ....  | 17          |
| Figure 8. Air Void Measurement Sequencing. ....  | 18          |
| Figure 9. Automated Immersion and Weighing in Water.....   | 19          |
| Figure 10. Automated SSD Concept.....  | 19          |
| Figure 11. Single-Temperature Bath Approach.....   | 21          |
| Figure 12. Flow of Specimens for Cracking and Rutting Tests.....                                   | 21          |
| Figure 13. Simplified Depiction of a CT/RT Testing Load Frame with Combined CT/RT<br>Fixture. .... | 22          |
| Figure 14. Rapid Cooling Unit.....   | 23          |
| Figure 15. Specimen Temperature Drop with Time Using the Setup Shown in Figure 14.....             | 24          |
| Figure 16. Rapid Cooling Unit with Two Fans.....   | 24          |
| Figure 17. Specimen Temperature Dropping Curve Using the Setup Shown in Figure 16.....             | 25          |
| Figure 18. Test Setup for Measuring Specimen: Dry Weights, Weight in Water, and SSD<br>Weight..... | 26          |
| Figure 19. Specimen Drying Unit.....   | 27          |
| Figure 20. Computer Control Interface for Specimen Air Void Measurement. ....                      | 27          |
| Figure 21. Final Temperature Conditioning Unit. ....   | 28          |
| Figure 22. Final Material Testing Unit with a Conveyor Belt for Trashing Tested<br>Specimen.....   | 29          |
| Figure 23. Robotic Arm: UR5e.....  | 29          |
| Figure 24. AMAZE Device.....   | 30          |
| Figure 25. Air Void Measurement Comparison. ....   | 31          |
| Figure 26. Repeatability of Air Voids Measured by AMAZE.....                                       | 31          |
| Figure 27. Repeatability of Air Voids Measured by Two Experienced Lab Technicians. ....            | 32          |
| Figure 28. IDEAL-CT Results Comparison. ....   | 32          |
| Figure 29. IDEAL-RT Results Comparison. ....   | 33          |

## LIST OF TABLES

|   | <b>Page</b> |
|---|-------------|
| Table 1. Asphalt Mixture Cracking Tests Including Commonly Used and Latest Test<br>Methods.....     | 13          |
| Table 2. Asphalt Mixture Rutting Tests Including Both Commonly Used and Latest Test<br>Methods..... | 14          |



# CHAPTER 1. INTRODUCTION

## BACKGROUND

Every year, millions of tons of asphalt mixes with billions of dollars in cost are placed on roads in Texas. The quality of asphalt mixes has always been a concern for the Texas Department of Transportation (TxDOT) because repairing pavement distresses and failures (such as fatigue cracking and rutting) could cost taxpayers millions of dollars annually. Currently, TxDOT is implementing a balanced mix design initiative with a goal of designing durable mixes. However, TxDOT engineers are facing three challenges:

- Achieving quality control and quality acceptance (QC/QA) with measuring mix engineering properties: A good mix designed with balanced cracking and rutting resistance in the laboratory may not guarantee good performance in the field because of variations in asphalt mix production and placement. Regardless of how well a mix is designed in the lab, if it deviates from its original design during production, which is often the case, its field performance is in jeopardy. Currently, neither cracking nor rutting tests are conducted as part of QC/QA during production to evaluate asphalt mix cracking or rutting resistance, or to screen out cracking- or rutting-prone mixes from being paved on the road. This lack of testing exists because both the asphalt industry and TxDOT are shorthanded. Another difficulty involves rapidly cooling, conditioning, and testing hot cylindrical specimens immediately out of a Superpave gyratory compactor mold.
- Hiring and retaining staff: In the last several years, many employees have retired, and the skills associated with that workforce are now gone. Consequently, TxDOT is short of staff and skills. At the same time, hiring new and retaining existing staff has become a struggle for TxDOT and the asphalt industry.
- Ensuring laboratory safety: Safety at all levels and for all employees has always been the top concern of TxDOT. In the laboratory, the top safety concern is preventing workers from injury associated with the hot asphalt, large masonry saws, high-force testing machines, and toxic chemicals typically found in an asphalt material testing lab.

Automation of the most essential laboratory tests or parts of the testing processes can alleviate some of these challenges. Therefore, the overall goal of this project was to develop the Asphalt Mixture Automated Testing System with Zero Intervention (AMAZE).

## REPORT ORGANIZATION

This report contains the following chapters:

- Chapter 1 provides background information relative to the project.
- Chapter 2 discusses conceptualization of laboratory test automation.
- Chapter 3 describes the AMAZE conceptual model development.
- Chapter 4 documents the actual realization and evaluation of AMAZE.
- Chapter 5 presents the implementation plan for AMAZE.
- Chapter 6 summarizes the conclusions and recommendations for this project.



## CHAPTER 2. CONCEPTUALIZATION OF LABORATORY TEST AUTOMATION

### INTRODUCTION

Robotics and laboratory automation are relatively new to the asphalt industry. This chapter first describes some terminology related to this project and then discusses the conceptualization of laboratory test automation.

### TERMINOLOGY

Early development of the **programmable logic controller (PLC)** was intended to replace banks of switches. The technology has evolved significantly to its current state that allows not only control of processes by switching but also closed-loop analog and digital feedback control of sophisticated processes using sensors like load cells and digital encoders. One advantage of the PLC is that it is fairly well insulated from the vagaries associated with personal computer (PC) operating systems. The central processing unit on a typical PLC is basically its own computer with its own operating system. Once it is disconnected from a PC after it has been programmed, it is a very robust device that is used in a wide range of industries, including those that are hazardous, such as petrochemical plants.

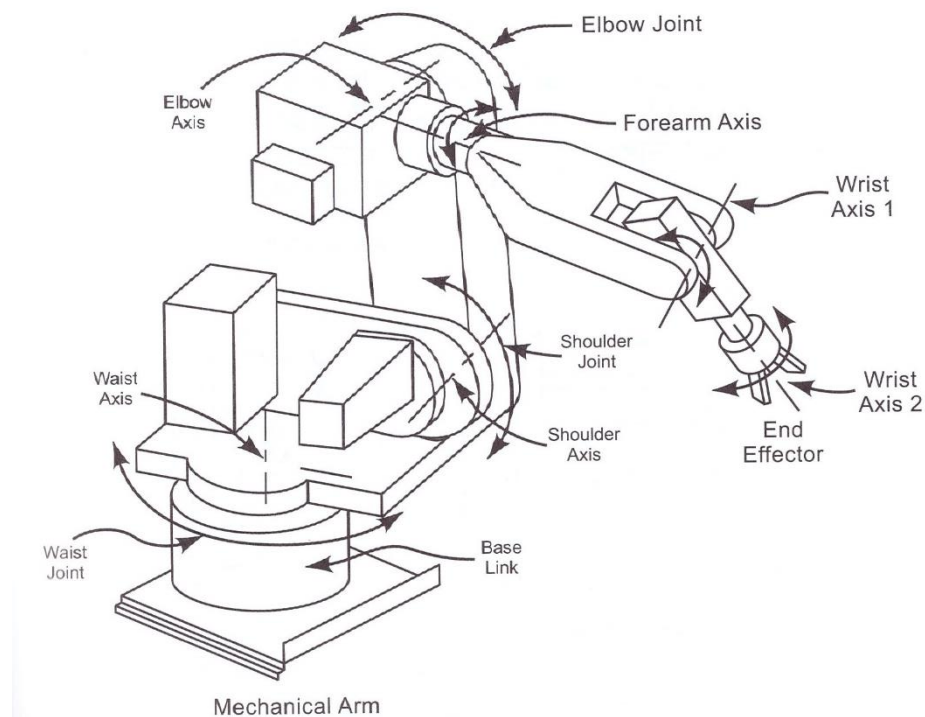
**Material handling** is a generic term used to describe the movement of materials throughout an enterprise. Although usually used in conjunction with heavy objects that are typically moved with machinery such as overhead cranes and forklifts, the term is also used in this document to describe movement of materials and specimens from one point to the next by any means available, including by hand, on a tray, or on a wheeled pushcart.

**Six sigma** ( $6\sigma$ ) is a term briefly mentioned herein. It is a reference to variation (generally assuming a normal statistical distribution curve) that describes the output of a process that is 99.99966 percent acceptable (Tapping 2010). Six sigma provides a target and quantitative metrics for identifying and reducing defects.

**Lean** enterprises are those that have a production program in place that ensures quality output with very little wasted material or effort. Many of these enterprises use six sigma metrics to evaluate the quality and efficiency of their program and to measure progress toward their customer-focused goals. In a manufacturing environment, it is often the case that a U-shaped grouping of machines/operations results in a very efficient use of materials, tools, and staff, and/or automation/robotics. These groupings are usually referred to as **manufacturing cells**. In this document, the laboratory version of a manufacturing cell is referred to as a **laboratory production cell**, or a **QC/QA production cell**, depending on the context.

The term **programmable automation technologies** is sometimes used to refer to generalized equipment that is made general purpose through the use of programmable user interfaces like those used for computer numerical control machines, PLC, and robots. For the purposes of this study, two forms of automation—dedicated and general purpose—were considered candidates for use in the laboratory and categorized more according to functionality than control interface:

- **Dedicated** solutions tend to be less expensive to implement, but they are more limited in capabilities because they are dedicated to a specific operation in a specific application. This type is basically interchangeable with the industry terminology **fixed automation**. These solutions may or may not be programmable with an electronic interface. Those that are not programmable may rely on limit switches, cams, and/or other types of simple mechanical or electromechanical controls. They tend to be one or two axis devices or cam systems with a motor drive. An example of a dedicated solution without an electronic interface other than an on-off switch would be the older soils/base drop hammer compaction devices that used a guide rod and motor system to semi-automate the compaction process and decrease reliance on a technician manually raising and dropping a weight from a standard height and moving it around between drops.
- **General-purpose** devices tend to have higher initial costs, but they are more capable. These include industrial robots with electronic control interfaces that can be programmed to do many different tasks either within one program or by changing programs to suit the task of the day. Therefore, these machines tend to be better than dedicated solutions for procedures that (a) may change significantly over time, (b) are fairly complex, or (c) need to be portable to move from one location (or operation) to another. They tend to mimic human handling operations, so they are good for relatively complex or hazardous repetitive material handling tasks and have multiple axes of movement (e.g., degrees of freedom, or joints). Figure 1 presents the terminology describing a six-axis robot. The terminology generally follows that of the human body, with the exception of the **end effector**. In this report, the end effector is also referred to as the **gripper** or the **hand**.



**Figure 1. Robot Terminology (Kandray 2010).**

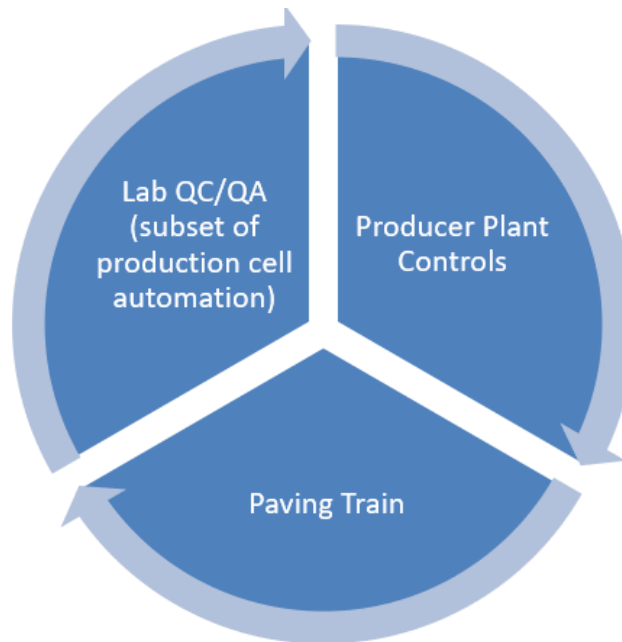


## CONCEPT OF LABORATORY TEST AUTOMATION

When looking at training video productions, any place where an operator's hand is shown operating a switch, operating a computer, or handling a specimen is a candidate for automation. Typically, automation can perform these tasks more quickly, precisely, safely, and consistently than the average human operator. The need exists to develop a laboratory production cell that:

- Produces a report (and/or control signals to other upstream and downstream operations) on the properties of hot mix.
- Minimizes the time between molding and reporting.
- Uses automation when feasible and appropriate.
- Makes efficient use of employee capabilities while enhancing employee safety.

The focus is on laboratory processes in general and specific test suites in particular. However, the conceptual approach can be extended to field construction and testing operations without much imagination. While a test suite automation is discussed herein, the scope of the concept must be larger than a test suite. An automation concept for transportation construction is shown in Figure 2, where the laboratory test suite, or production cell, might fit in the overall pavement construction process.



**Figure 2. Automation Concept for Transportation Construction.**

Most managers have heard of, but may not understand, the terms “six sigma” and “lean.” Detailed understanding of the terms is beyond this discussion here. In simplistic terms, lean is a system for reducing waste, and six sigma provides a target and quantitative metrics for identifying and reducing defects. A relatively new buzzword, robotic process automation (RPA), has also been thrown into the management lingo. RPA is more of a software aspect than a hardware robot application, but some of the ideas transfer over to hardware. Successfully implementing these ideas provides real benefits to the agency, not just qualitative “fuzzy feeling”

results. For example, Jack Welch, CEO of GE at the time, reported that for three years, 1996–1998, the GE six sigma program saved the company more than \$2 billion (Pande and Holpp 2002). The  $6\sigma$  measurement arises simply from the statistics associated with a statistical distribution curve. What does this mean for a transportation agency? Think about it in terms of the plot from the American Association of State Highway and Transportation Officials (AASHTO) Material Reference Library showing the scatter of test results from round-robin testing. That scatter will be a lot smaller at  $6\sigma$  than at  $2\sigma$ . Alternatively, think about it in terms of paved highway miles. If at  $6\sigma$ , there is only 3.4 miles of bad pavement in a 1,000,000 mile network (pessimistically assumes that there is only one opportunity for defects per mile), but there will be 308,537 miles of bad pavement in a 1,000,000 mile network if at  $2\sigma$ .

The point of the above discussion is to provide background for considering the scope of automation projects for the laboratory. In order to get to a very low defect rate ( $6\sigma$ ), one of the tools that is used is value stream mapping (VSM), which is basically a graphical way of looking at the end-to-end production process within the agency. A current state map is generated to illustrate the current processes, a plan for improving the current approach is developed, a future state map is generated, and implementation of process improvements is started to move the agency from the current state to the future state. While the scope of this research did not envision a full-scale VSM exercise (even though there was a cursory examination of the current state by looking at the path of material/specimen throughput), there is value in keeping the big picture in mind during automation efforts. For example, consider the following two somewhat different takes on the subject (Walby 2015):

*The first rule of any technology used in a business is that automation applied to an efficient operation will magnify the efficiency. The second is that automation applied to an inefficient operation will magnify the inefficiency.*

– Bill Gates

*So our view is different. Forget perfection. Automate your processes in their current, or near current form. Take the path of least resistance, the one that doesn't require lengthy redesign or complex re-architecting. Take the human actions, and replicate them in automation. Do it now, and do it quickly. ... Will you end up with a perfect process? No. Will you end up with a more efficient process than you had pre-automation? In most cases, absolutely yes. And perhaps that[ 's] good enough. Or perhaps those resources you've just freed up with your automation can be refocused on doing a more fundamental redesign to come up with the perfect process. Either way, you've delivered benefit.*

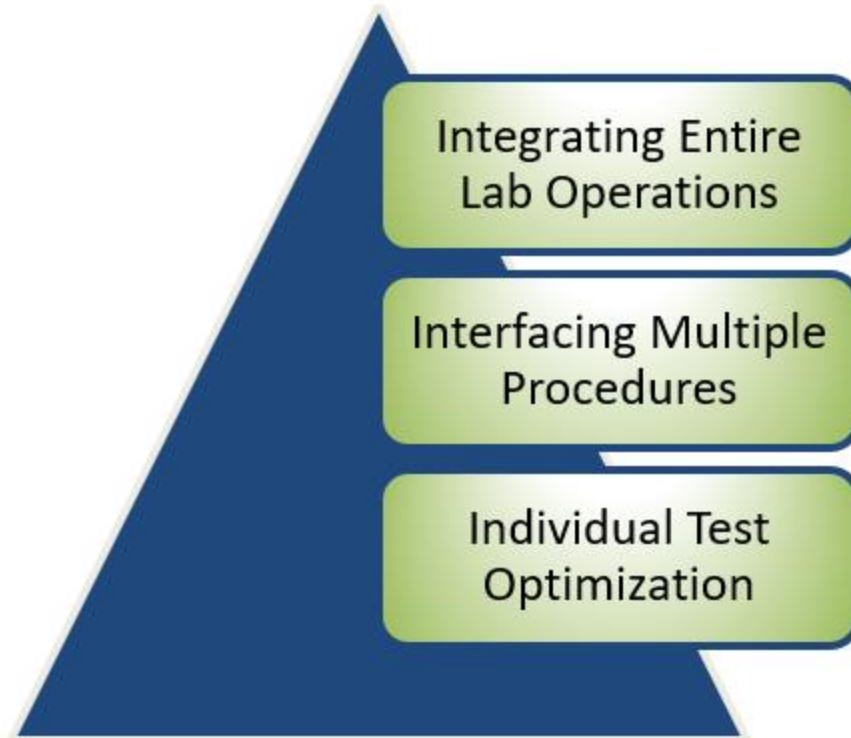
– Terry Walby

Both of these points of view have merit. In terms of the preceding discussion on  $6\sigma$  and VSM, one take on these points of view is that Gates may be suggesting that one really wants to get the process into a lean state of practice by successfully attaining the agency's future state map and perhaps also reaching the  $6\sigma$  defect level prior to automating. Although Walby may be suggesting that is a great idea, for those that cannot feasibly delay for the six months to years it

might take to successfully develop and implement a future state map, benefits can be achieved even if the agency has not met its future state goals before automating. In a perfect world, running automation, 6 $\sigma$ , and VSM efforts in parallel along the same timeline may be the optimal approach, which is why Walby's comment that freed-up resources might be used to work on perfecting processes is a valuable one.

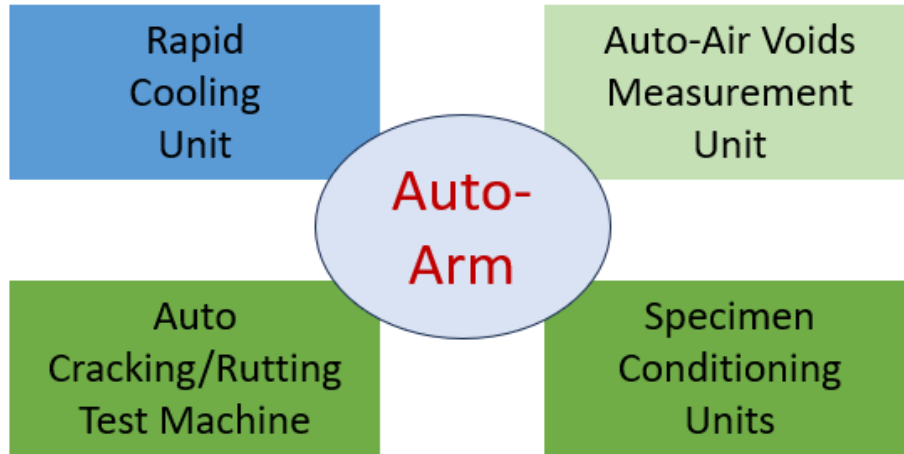
In this study, programmable automation was the focus, and other efforts such as lean, 6 $\sigma$ , and VSM are left to the agency's discretion. The term "programmable" as used here means that the automation should have at least some components that can be easily adapted to new functionality. This adaptability is intended to make it relatively easy and fast to alter the mechanics of the automation to fit changing tests and processes so that as processes are perfected, the benefits of the initial capital investment in automation may continue to be realized. A three-tiered laboratory automation development process is envisioned (Figure 3):

- **Tier 1: Individual Test Optimization** comprises (a) optimizing tests to take advantage of automation activities, and (b) replacing cumbersome tests with new tests optimized for efficiency. For example, a particular pair of tests might be used to fully evaluate/specify the acceptability of a material. If that pair of tests uses the same basic equipment but different fixtures, automation can be used to take the operator out of the fixture swapping process. Alternatively, if the pair of tests is done on separate host equipment (e.g., the overlay and the Hamburg), optimization may involve an alternative testing system that produces balanced evaluation of rutting and cracking potential.
- **Tier 2: Interfacing Multiple Procedures** comprises all activities appropriate to streamlining full processes, from raw material to finished material evaluation. In this category, an example might be the interfacing required to automate a process involving multiple steps, such as wet sawing, drying, inserting in a testing machine, running a test, and disposing of the tested material.
- **Tier 3: Integrating Entire Lab Operations** builds upon the foundations of automation to optimize flow through the lab, from receipt of materials, to engineering measurement and compliance evaluation, to final material disposition.



**Figure 3. Tiered Process for Laboratory Automation Implementation.**

This study focused on Tiers 1 and 2—**individual test optimization** and **interfacing multiple procedures**—as the initial development efforts and proof of concept (Figure 4). The proof of concept was intended to provide a model for developing **laboratory production testing cells**, or **AMAZE**. In this study, the testing and interfacing involved a rapid cooling system to cool specimens after gyratory molding, an automated method of performing air void measurement, a final temperature stabilization station, an integrated test procedure for cracking and rutting, and automated specimen handling equipment (Figure 4). The end result was a cracking and rutting evaluation cell targeting near-real-time QC/QA goals. The model provides a guide for future efforts to establish similar cells for other tests of asphalt binders and mixes (such as binder rheology testing and hot-mix mixing and molding), in addition to applications outside the hot-mix lab (e.g., for aggregate, soils, and Portland cement concrete).



**Figure 4. Individual Test Optimization and Interfacing.**

### **SUMMARY**

This chapter defined various terminology, such as  $6\sigma$  and programmable automation technologies, that paved the way for conceptualizing laboratory test automation. Specifically, a three-tiered laboratory automation development process was envisioned, and Tiers 1 and 2—individual test optimization and interfacing multiple procedures—were the main focus for this project for the initial development efforts and proof of concept.



## CHAPTER 3. AMAZE CONCEPTUAL MODEL DEVELOPMENT

### INTRODUCTION

This chapter presents cracking and rutting tests selected for AMAZE and then discusses the conceptual design developed for AMAZE.

### SELECTION OF CRACKING AND RUTTING TESTS FOR AMAZE

Many cracking and rutting tests have been developed and used for asphalt mix design, pavement design, or performance modeling. Table 1 lists commonly used cracking tests, including:

1. Disk-shaped compact tension (DCT) test.
2. Semi-circular bend (SCB) test for fracture energy at low temperature.
3. SCB test for critical strain energy release rate ( $J_c$ ) at intermediate temperature.
4. SCB test for flexibility index at intermediate temperature.
5. Indirect tensile (IDT) test for energy ratio developed at the University of Florida.
6. Texas overlay test.
7. Bending beam fatigue (BBF) test.
8. Ideal cracking test (IDEAL-CT).
9. Cyclic fatigue test with asphalt mixture performance test (AMPT).

Similarly, Table 2 lists some typical rutting tests and some new developments, including:

1. Marshall stability test.
2. Hamburg wheel tracking test (HWTT).
3. Asphalt pavement analyzer (APA) rutting test.
4. Flow number test.
5. Superpave simple shear test (SST).
6. Incremental repeated load permanent deformation (iRLPD) test.
7. Stress sweep rutting (SSR) test.
8. High-temperature IDT strength test.
9. Ideal rutting test (IDEAL-RT).

Each of these cracking and rutting tests has its own features and applications, but that does not mean that they all are suited for production QC/QA because production QC/QA testing has two constraints or requirements:

- **Rapidity:** One of the major differences between QC/QA and mix design (pavement design or performance prediction) is the constraint of testing time. It is tolerable to design a mix within weeks (or even months), but a contractor or a state agency needs to know whether the asphalt mix produced at the plant meets the specification within hours. Thus, it is preferred to complete QC testing within hours after the plant mix is produced and transported by trucks to the job site. This requirement excludes many research-level test methods from consideration. For example, cyclic BBF tests often require days to prepare beam specimens and then to complete one beam fatigue test, so the BBF test is not suitable for production QC/QA, although it is a good research-level test method.

- Simplicity: QC/QA testing is performed at asphalt plants, which are often located in remote areas and may not have sophisticated laboratory testing machines or sample preparation tools (such as saw, drill/core machine). Thus, simple but performance-related tests are favored.










Considering these two constraints, the cracking test suitable for the production QC/QA is the IDEAL-CT because the IDEAL-CT does not require sample preparation or instrumentation, and it can be conducted with low-cost test equipment within 2 minutes (after achieving the 25°C test temperature). The IDEAL-CT result is repeatable and sensitive to asphalt mix composition (aggregate, binder, recycled materials) and aging conditions. It also has good correlation with field cracking performance (Zhou et al. 2017, West 2019).

Meanwhile, three rutting tests could be used for the production QC/QA: Marshall stability test, high-temperature IDT strength test, and IDEAL-RT. The Marshall stability does not have a good correlation with field rutting performance (Brown and Cross 1992). Thus, it is excluded from consideration. The high-temperature IDT strength test measures the tensile strength of asphalt mixes, which captures the cohesion component of shear strength of asphalt mixes, as described by Christensen and Bonaquist (2002). However, it cannot capture the friction angle that also contributes to the shear strength of asphalt mixes. Compared with the high-temperature IDT strength test, the IDEAL-RT is preferred because it directly measures the shear strength of asphalt mixes. The IDEAL-RT is not only a simple, rapid test (completed in 2 minutes), it is also repeatable and sensitive to asphalt mix composition and aging. More importantly, the IDEAL-RT shear strength has good correlation with field rutting performance (Zhou et al. 2019).









In summary, the IDEAL-CT and IDEAL-RT were identified among many cracking and rutting tests as the candidate tests most suitable for the production QC/QA testing.



**Table 1. Asphalt Mixture Cracking Tests Including Commonly Used and Latest Test Methods.**

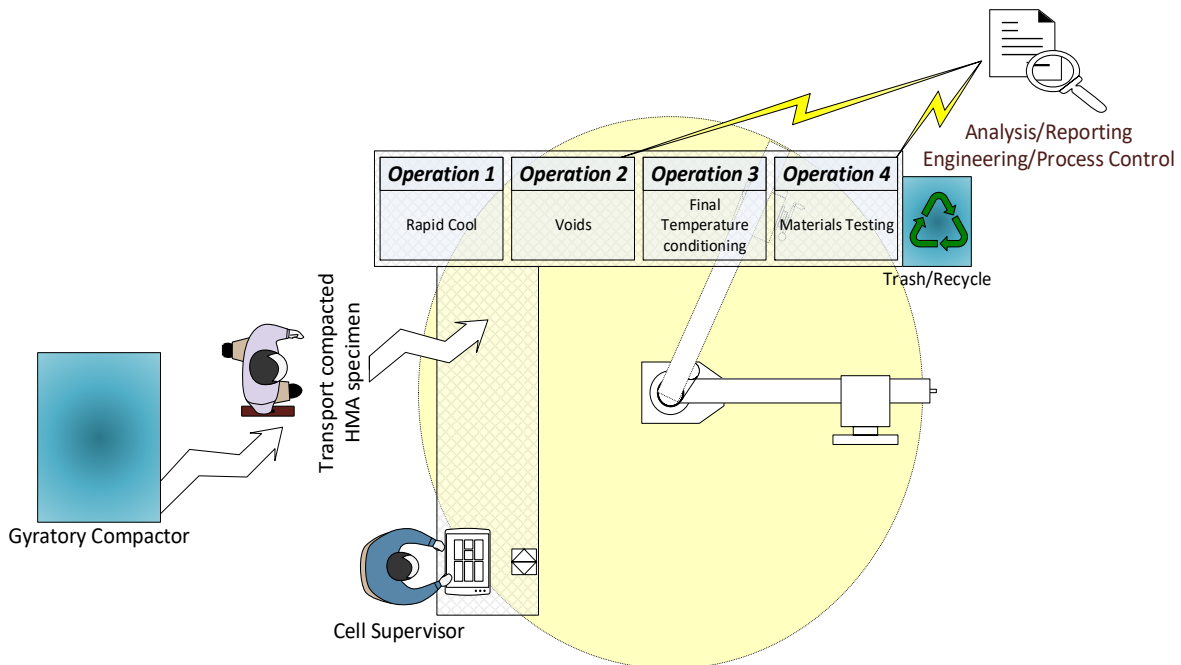
| Test standard                            |  | Cracking parameter                           | Test temperature         | No. of specimens   | Specimen preparation and testing time   | Equipment cost | Overall practicality for QC/QA |
|--|--|--|--------------------------|--------------------|---|----------------|--------------------------------|
| ASTM D7313<br>DCT                        |   | Fracture energy                              | PG low+10°C              | 3                  | 5 cuts and 2 holes per specimen; total time: 4–5 days                                 | \$50,000       | Poor                           |
| AASHTO TP105<br>SCB-low temp.            |   | Fracture energy                              | PG low+10°C              | 3                  | 5 cuts per 2 specimens and 2 sensors; total testing time: 3–4 days                    | \$100,000      | Poor                           |
| ASTM D8044<br>SCB-Jc                     |   | Jc-Critical strain energy release rate       | 25°C                     | 12                 | 7 cuts per 4 specimens; total testing time: 7–8 days (including 5 days at 85°C aging) | <\$10,000      | Poor                           |
| AASHTO TP124<br>SCB-FI                   |   | Flexibility index                            | 25°C                     | 6                  | 5 cuts per 2 specimens; total testing time: 2–3 days (including sample drying)        | <\$10,000      | Fair                           |
| IDT-University of Florida method         |   | Energy ratio                                 | 10°C                     | 3                  | 2 cuts per specimen and 4 sensors; total testing time: 4–5 days                       | >\$100,000     | Poor                           |
| Tex-248-F<br>OT                          |   | Gc, crack resistance index                   | 25°C                     | 3                  | 4 cuts per specimen and gluing; total testing time: 3–4 days                          | \$50,000       | Poor                           |
| AASHTO T321<br>BBF                       |   | No. of cycles                                | 20°C                     | 3                  | 6 cuts per specimen; total testing time: 3–5 days                                     | >\$100,000     | Poor                           |
| AASHTO TP107<br>AMPT cyclic fatigue test |   | Fatigue damage parameters                    | Intermediate temperature | 4 (+3 for E* test) | 1 coring and 2 cuts per specimen and gluing; total testing time: 4–5 days             | \$85,000       | Poor                           |
| ASTM D8225<br>IDEAL-CT                   |  | Crack tolerance index (CT <sub>Index</sub> ) | 25°C                     | 3                  | No cutting or gluing; total testing time: 1 day                                       | <\$10,000      | Good                           |

**Table 2. Asphalt Mixture Rutting Tests Including Both Commonly Used and Latest Test Methods.**

| Test standard                              |   | Cracking parameter          | Test temperature         | No. of specimens | Specimen preparation and the total time (including specimen preparation and testing) | Equipment cost | Overall practicality for QC/QA |
|--|---|-----------------------------|--------------------------|------------------|--|----------------|--------------------------------|
| ASTM D6927<br>Marshall stability test      |    | Marshall stability          | 60°C                     | 3                | No cutting or gluing;<br>total time: 1 day   | <\$10,000      | Good                           |
| AASHTO T324<br>HWTT                        |    | Rut depth                   | 50°C<br>(others)         | 4                | 1 cutting per specimen;<br>total time: 2 days  | \$50,000       | Fair                           |
| AASHTO T340<br>APA                         |    | Rut depth                   | 64°C<br>(others)         | 4                | No cutting or gluing;<br>total time: 2 days  | >\$100,000     | Fair                           |
| AASHTO TP79<br>Flow number test            |    | Flow number                 | High temperature         | 3                | 1 coring and 2 cutting per specimen;<br>total time: 4 days                           | \$85,000       | Fair                           |
| AASHTO T320<br>Superpave SST               |    | Permanent shear strain      | High temperature         | 3                | Gluing and instrumentation;<br>total time: 2 days                                    | >\$100,000     | Poor                           |
| AASHTO TP116<br>iRLPD test                 |   | Minimum strain rate         | 55°C                     | 3                | 1 coring and 2 cutting per specimen and gluing;<br>total time: 4 days                | \$85,000       | Poor                           |
| AASHTO TP134<br>SSR test                   |  | Permanent deformation model | High and low temperature | 4                | 1 coring and 2 cutting per specimen and gluing;<br>total time: 4 days                | \$85,000       | Poor                           |
| ASTM D8360<br>IDEAL-RT shear strength test |  | Shear strength              | 50°C                     | 3                | No cutting or gluing;<br>total time: 1 day   | <\$10,000      | Good                           |

## AMAZE CONCEPTUAL DESIGN

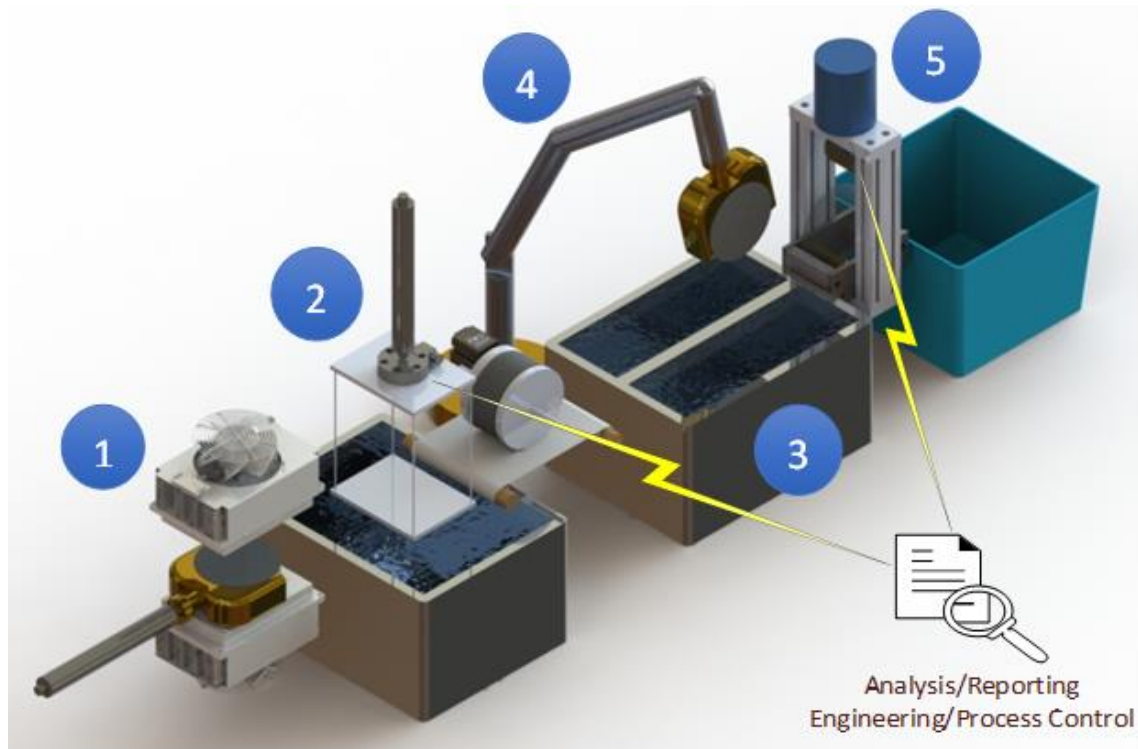
Figure 5 presents a schematic example of a lab production cell. Although not presented in a U-shaped arrangement, several of the stations are illustrated as being within reach of the robot arm depicted in the middle with the light yellow circle. There are four major automated workstations in the cell, all of which are fed by material handling processes and controlled by a supervisory function, and at least two of which feed data back to the supervisory function and to engineering/reporting. The current vision is for supervisory work to be done by a PLC, but a PC computer may also be used. The illustration shows a human as part of the supervisory function, but the automation process should reduce the time that human presence is required in the cell. A long-term goal might be lights-out production testing, which means the human supervisor would simply be on call to deal with problems in the cell when notified remotely by the process control functionality in the cell.



**Figure 5. QC/QA Production Cell Schematic.**

Figure 6 presents an implementation of the schematic in Figure 5. In this computer-aided design (CAD) model, the numbered components are:

1. A rapid cooling unit.
2. A weighing station for dry and wet weighing and an automated towel drying unit.
3. A final temperature conditioning unit.
4. A multi-axis specimen handling device (e.g., a general-purpose robot arm or a dedicated solution).
5. A materials testing unit with a recycling/trash bin.



**Figure 6. Potential Implementation of a Laboratory Production Cell.**

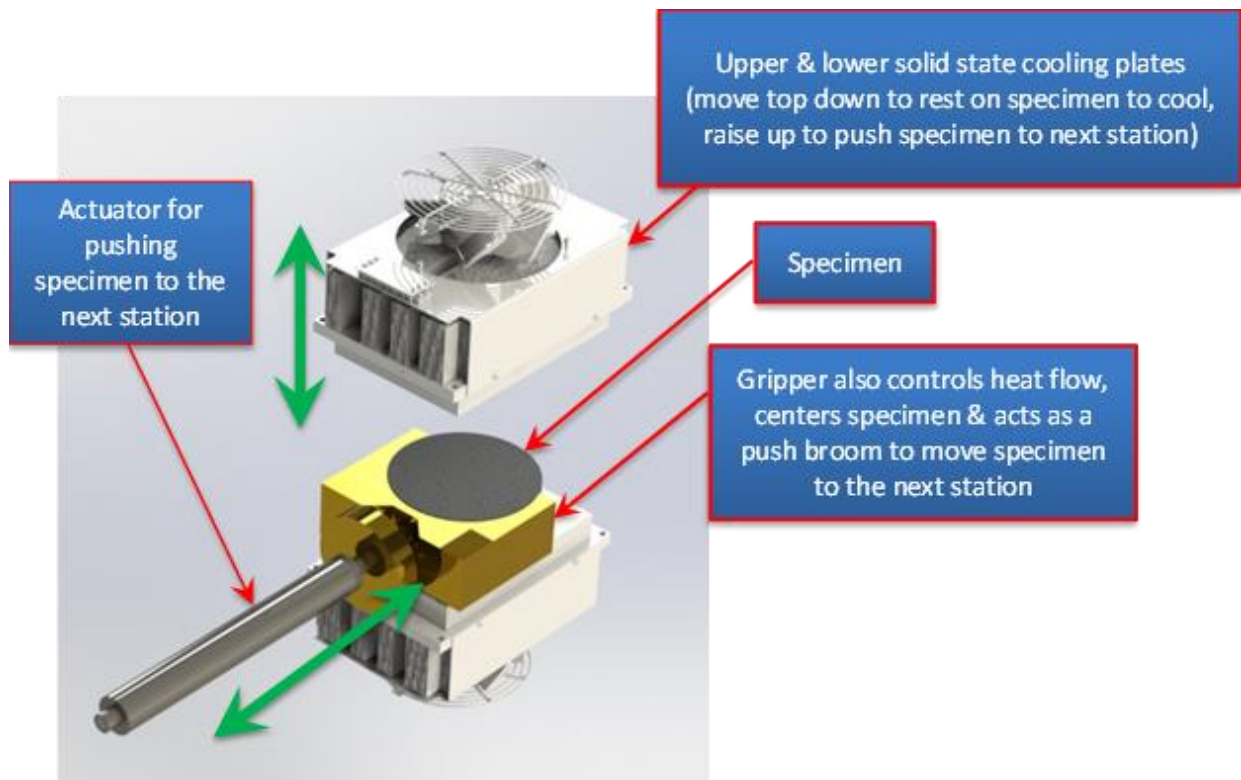
### **CAD Design for Rapid Cooling Unit**

Several options have been explored to rapidly cool a recently compacted specimen down to room temperature. The current procedure is typically to extrude it from the compaction mold, move it to a counter in front of a fan, and let it cool by air movement until it is either tested or put in an environmental chamber. A QC/QA test must do better than this. As noted earlier, it was beyond the scope of this research to address the specimen handling immediately after extrusion. Asphalt specimens are typically very tender at that point and require careful handling. Such handling might be the subject of additional cell development during follow-up studies, and the solution might be a robot with a specialized grip or spatula system that is instrumented for measuring force so that the stresses applied to the hot specimen can be standardized and controlled even better than would be possible with multiple technicians trying to match their grip strengths. Since the full process was beyond the scope of the initial research, the plan was to extrude the specimen, put it in front of a fan for the bare minimum of time to allow human handling, and transport it to the automation cell. In order to rapidly cool the specimen from that elevated temperature state down to room temperature, additional efforts were required. Environmental chambers were eliminated because they are too slow. The same appeared to be true of liquid (e.g., water) baths according to recent testing with a high-end reef tank aquarium refrigeration unit (although the highest horsepower units were not tested, and the recirculating water volume was on the low end, so there may still be a possibility of success with this approach). The approach chosen for further investigation was a plate cooler device (Figure 7). A large commercial version of this concept is found on fishing trawlers that need to process and freeze their catch in a very short time on board the fishing vessel. The unit envisioned for use in the

automated lab cell is much smaller than that used by fishing vessels, but the principle is similar. The operational sequence for this workstation is:

1. Receive a hot specimen from the upstream process (i.e., compaction and minimal fan cooling) and place it on a surface at the same height as the lower cooling plate.
2. Clamp the specimen with minimal force in the gripper (note: the specimen stays clamped in the gripper until step 6 because the gripper will provide insulation and/or possibly additional cooling).
3. Trigger the horizontal actuator to slide the specimen onto the lower cooling plate.
4. Trigger another actuator (vertical, not shown) to move the top cooling plate down on top of the specimen.
5. When the specimen temperature reaches room temperature (based on sensing and research on time required with various mixtures), raise the top plate and slide the specimen over to the next downstream workstation (void measurement).
6. Release the specimen clamp and retract the actuator to process the next specimen from the upstream process.

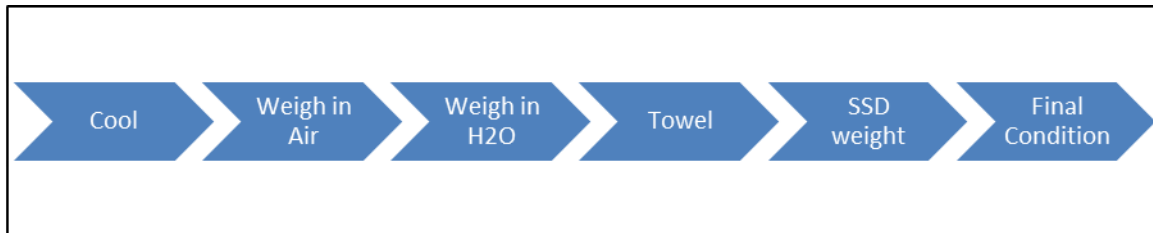
Although this scenario might be interpreted to have three degrees of freedom (horizontal, vertical, and the grip open/close) and might be easily controlled with PLC logic, it is considered a dedicated automation solution because it is specific to the operation.



**Figure 7. Rapid Cooling Concept.**

## CAD Design for Air Void Measurement Unit

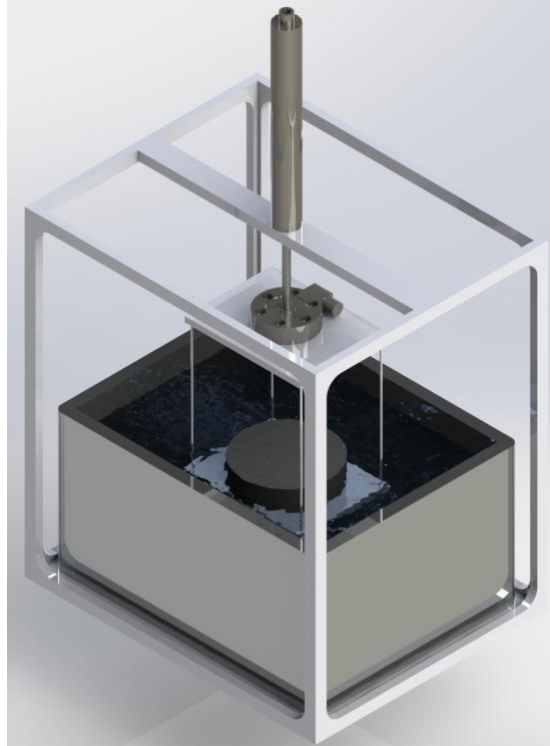
One method of obtaining voids uses the saturated surface dry (SSD) weight of the specimen in the computations. This process could benefit from automation. Figure 8 illustrates the sequencing of the tasks performed at this stage, along with the immediate upstream and immediate downstream tasks.



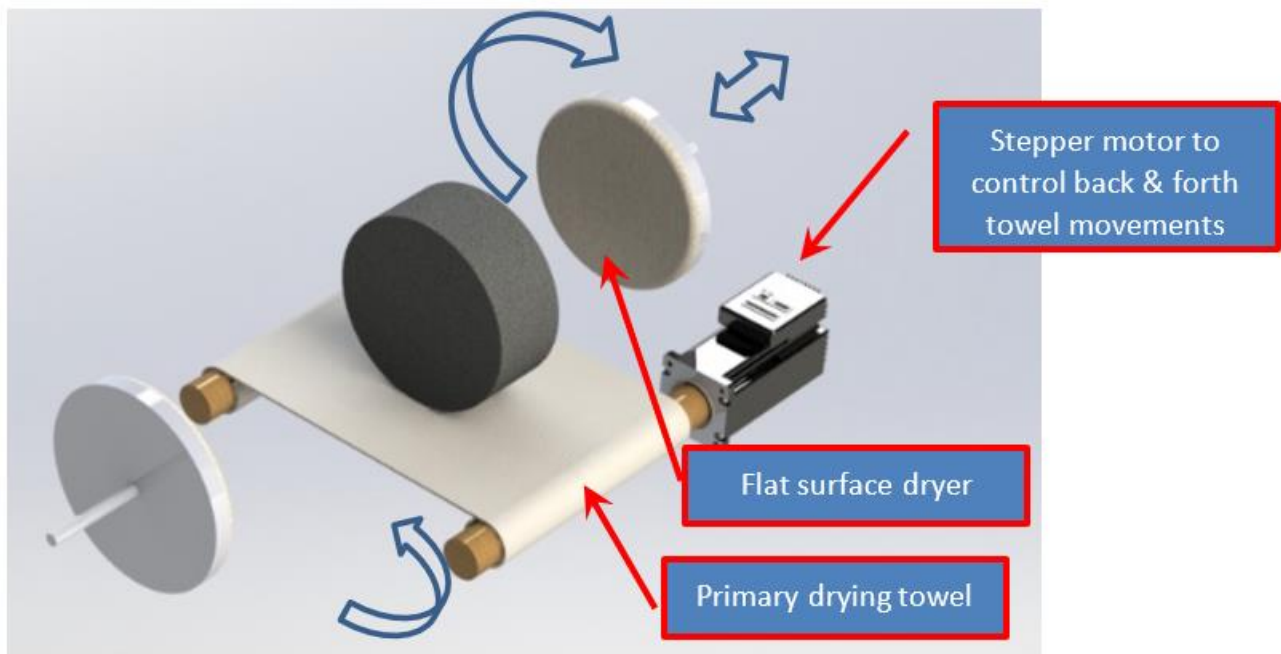
**Figure 8. Air Void Measurement Sequencing.**

Figure 9 and Figure 10 present automation of the four tasks shown in the middle of the figure. The steps involved in this process are:

1. Push the specimen onto the weighing basket plate from the upstream operation (rapid cooling).
2. Weigh the specimen in air and electronically record the weight in the analysis program.
3. Lower the specimen into the water using the actuator.
4. Weigh the specimen in water, transmit the data, and lift the specimen back out of the water with the actuator.
5. Push or pick and place the specimen on the automated SSD towel and close the flat surface dryer disks on the specimen.
6. Roll the towel back and forth for the prescribed time.
7. Put the specimen back on the weighing basket plate, weigh SSD, and transmit the data.
8. Remove the specimen from the weighing basket plate and move it to the next downstream operation.



**Figure 9. Automated Immersion and Weighing in Water.**



**Figure 10. Automated SSD Concept.**

Figure 9 shows the specimen being lowered into the water by the vertically oriented actuator at the top of the figure. The load cell mounted to the rod end of the actuator measures the weight in water and reports that weight to the data acquisition and analysis program to be combined with

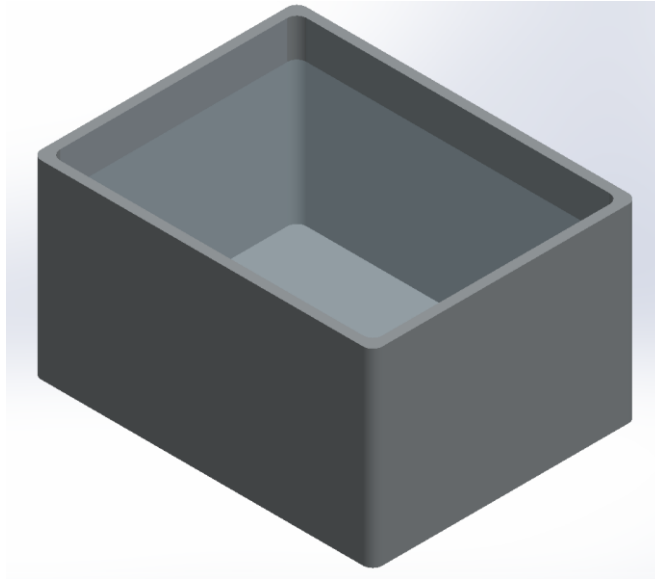
the weight in air and SSD weight measurements taken in other parts of the sequencing diagram to compute voids.

Figure 10 presents an approach to preparing for SSD weight measurement. The approach is shown with the cylindrical axis of the specimen horizontal, but other orientations may be possible. The model shows two dowel rods with each end of a towel wrapped around them. A stepper motor is attached to one of these dowels, and another device (e.g., another stepper motor, or a constant force spring like a clock spring) is attached to the other dowel. The stepper motor drives the entire drying process for the exact amount of time required by the specification. Also shown in the figure are two flat surface dryers. These are similar to car polishing bonnets, but they freewheel in rotation and have actuators (not shown) that push them in and out along the axis of rotation so that they can be snugged up against the specimen for drying and retracted when the specimen needs to be moved. When the towel is moved back and forth by the stepper motor, the flat disks simply rotate to allow the specimen to rotate, enabling the system to dry both flat surfaces and the cylindrical surface at the same time. For example, when looking at the device from the bottom left corner of the figure, the arrows show a counterclockwise rotation by the stepper motor, which in turn causes the flat surface dryer to rotate clockwise. In order to dry the entire cylindrical surface, the length of the towel must be more than the circumference of the specimen. Techniques to keep the towel and polishing bonnets at the correct level of moisture have not been finalized but could be done with moisture sensors or simply by researching the median time and number of specimens that generate a need to swap out these components for fresh ones. Also, for the towel component, it may be possible to put a large number of wraps on the towel bar and then use the stepper motor(s) to renew the part of the towel that is in contact with the specimen simply by wrapping the old part onto one dowel and rolling the new part off the other dowel.

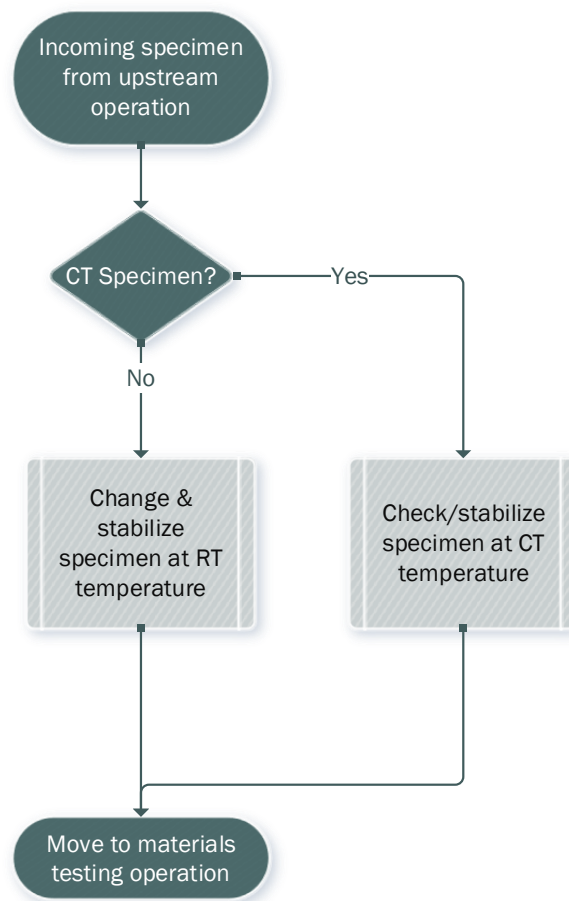
### **CAD Design for Temperature Conditioning Unit**

For the IDEAL-CT test, the specimen temperature should be at or very close to the testing temperature at the end of the SSD operation. However, the IDEAL-RT specimen must go through an additional temperature adjustment to a specified temperature that is based on local conditions and may not be the same for every mix, even at the same lab. In the event that CT specimens do not need any further conditioning before testing, a single-temperature conditioning unit (e.g., a fluid bath [Figure 11]) for the RT specimens may be all that is necessary. If an additional bath is required, a divided system may be used. This final temperature change was planned to be done with a fluid bath, but other options may work, depending on how much different the RT test temperature must be from room temperature. Figure 12 gives the flowchart for routing the two types of specimens through the cell.





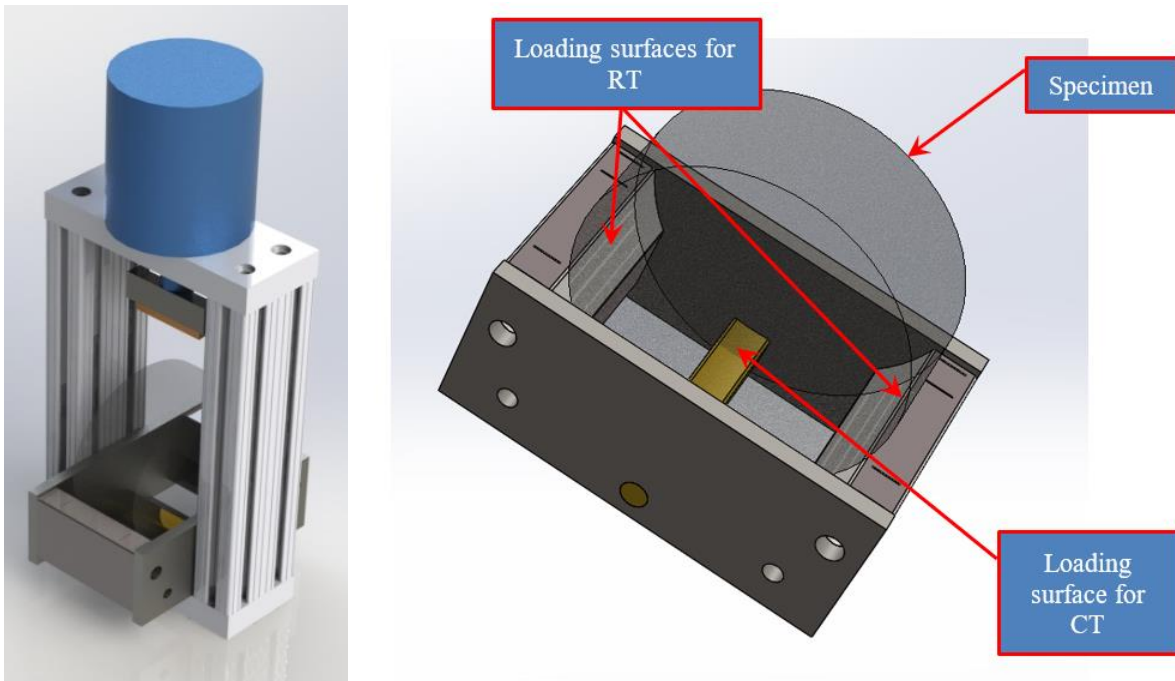
**Figure 11. Single-Temperature Bath Approach.**



**Figure 12. Flow of Specimens for Cracking and Rutting Tests.**

## CAD Design for Material Testing Unit

Although a robot arm could be configured to perform testing and material handling, use of a load frame (Figure 13) is a more realistic and economical solution for testing the specimen. The CT/RT jig is placed in the load frame to accomplish the tests. One solution to automate the jig is to manufacture the CT load strip with an eccentric shaft location so that when the shaft is turned 180 degrees (e.g., by a stepper motor or solenoid or cam system), the CT loading surface is raised up and supports the specimen above the RT surfaces. When it is rotated back to zero, the CT surface is pointing down and the specimen is resting on the two RT surfaces with a clearance between the CT bar and the bottom of the specimen to allow for development of shear strains and failure deformations.



**Figure 13. Simplified Depiction of a CT/RT Testing Load Frame with Combined CT/RT Fixture.**

## SUMMARY

This chapter showed the process used for selecting the IDEAL-CT and IDEAL-RT as the cracking and rutting tests for AMAZE development. Furthermore, the conceptual CAD models developed for each of the five major units of the AMAZE device were described.

## CHAPTER 4. AMAZE ACTUAL REALIZATION AND EVALUATION

### INTRODUCTION

This chapter first documents the actual realization of the conceptual design for each unit of the AMAZE. Then, the evaluation of the completed AMAZE device is presented through a comparison of the asphalt mixture properties measured by AMAZE and laboratory technicians.

### ACTUAL REALIZATION OF THE AMAZE CONCEPTUAL DESIGNS

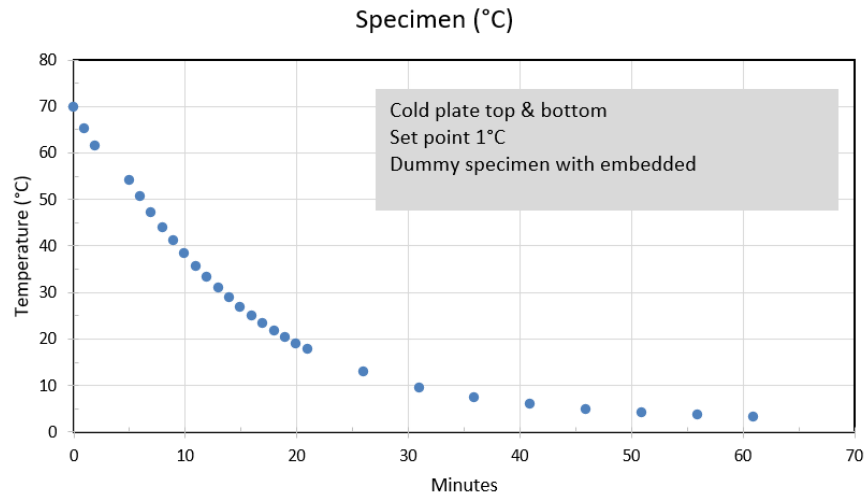
Once the conceptual designs were completed for each unit of AMAZE, the research team started building/revising each individual unit. The building and revision processes were not straightforward but were instead trial-error processes. In some cases, a completely new design had to be developed. The following text describes the process for each unit.

#### Actual Realization of Rapid Cooling Unit

Based on the conceptual design of the rapid cooling shown in Figure 7, the research team purchased two thermoelectric coolers and mounted them in a frame (Figure 14). Next, a series of tests were conducted. Figure 15 shows an example of the specimen temperature drop with time. It took 15 minutes to drop the specimen temperature at the center of the specimen from 70°C to 25°C. However, the thermoelectric cooler used in the rapid cooling unit shown in Figure 14 is relatively expensive. To reduce the cost, the research team is currently evaluating a very simple cooling setup (Figure 16). The new setup only needs two powerful fans. Figure 17 shows the temperature dropping curve. The data shown in Figure 17 are acceptable.



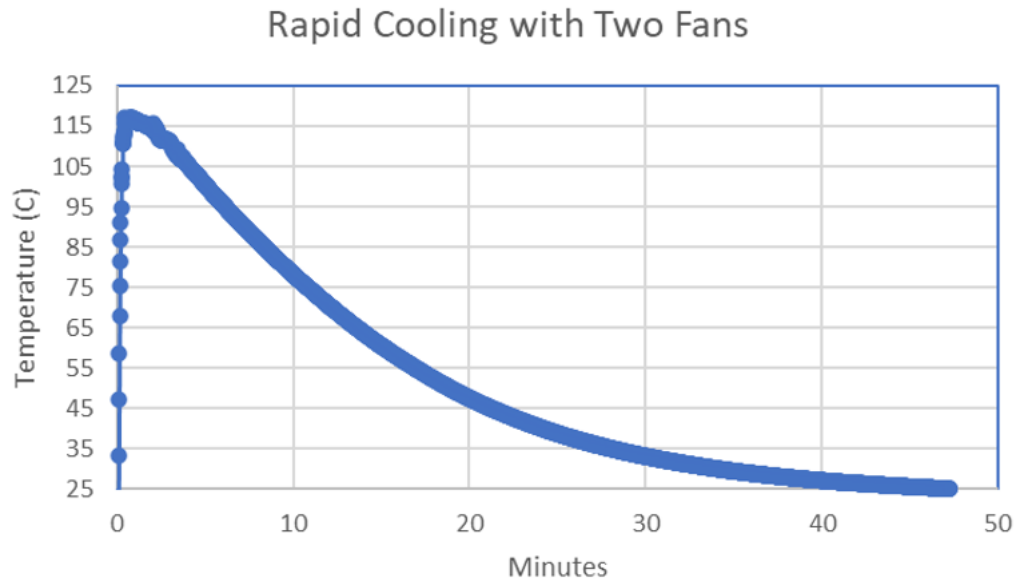
**Figure 14. Rapid Cooling Unit.**



**Figure 15. Specimen Temperature Drop with Time Using the Setup Shown in Figure 14.**



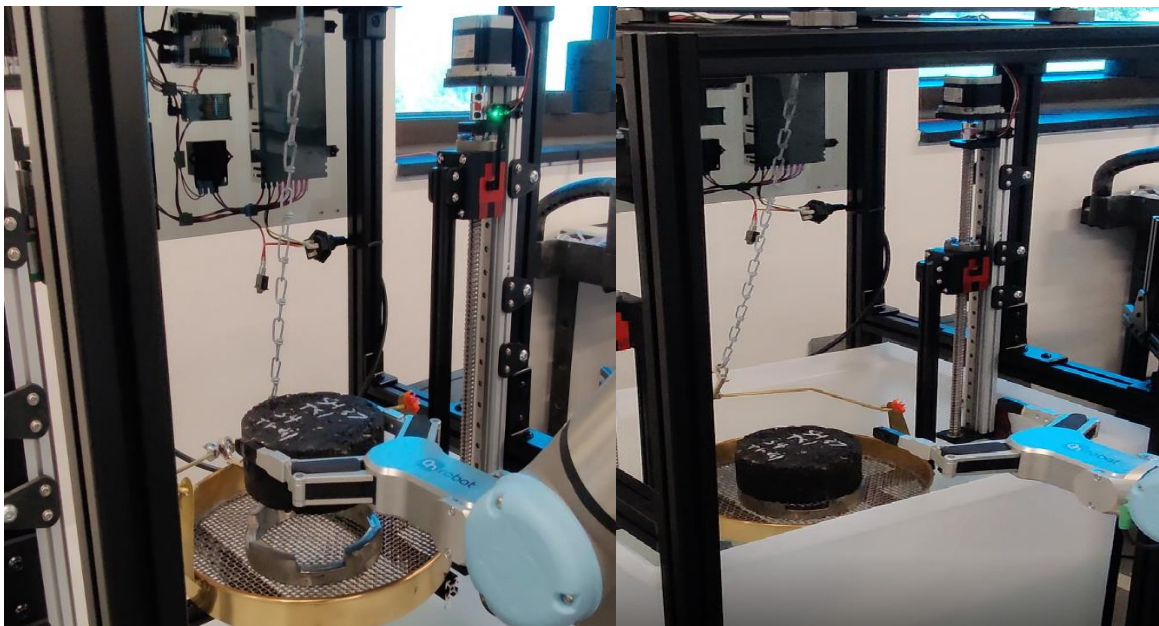
**Figure 16. Rapid Cooling Unit with Two Fans.**



**Figure 17. Specimen Temperature Dropping Curve Using the Setup Shown in Figure 16.**

#### **Actual Realization of Air Voids Measurement Unit**

Based on the conceptual design of the air void measurement subsystem illustrated in Figure 8, Figure 9, and Figure 10, the research team purchased some of the components and manufactured a trial setup. However, the trial did not turn out as expected. Researchers then went back to the traditional way of measuring the air voids of asphalt specimens using a digital scale and water tank. Figure 18 shows the setup to measure the dry weight and the weight of a specimen in the water. First, the robot arm puts the specimen on the scale to measure its dry weight. Then the robot picks up the specimen and places it on a basket, followed by lowering the basket with the specimen into a water tank through two linear actuators to measure the weight of the specimen in the water. Next, the two linear actuators lift the basket and the specimen. Then the wet specimen is removed by the robot arm to perform the SSD process (Figure 19). After that, the robot arm moves the SSD specimen to the scale to record the SSD weight. Based on the recorded dry weight, weight in the water, SSD weight, and material rice value, the computer automatically calculates and outputs the specimen air voids (Figure 20). The accuracy and consistency of the final air void measurement subsystem are discussed later.



**Figure 18. Test Setup for Measuring Specimen: Dry Weights, Weight in Water, and SSD Weight.**

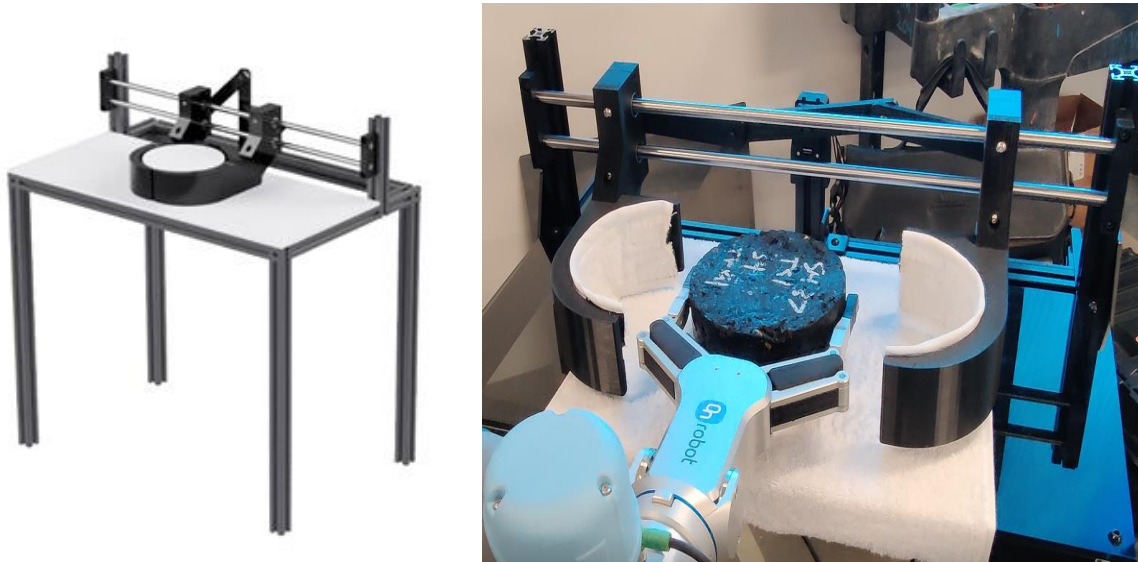


Figure 19. Specimen Drying Unit.

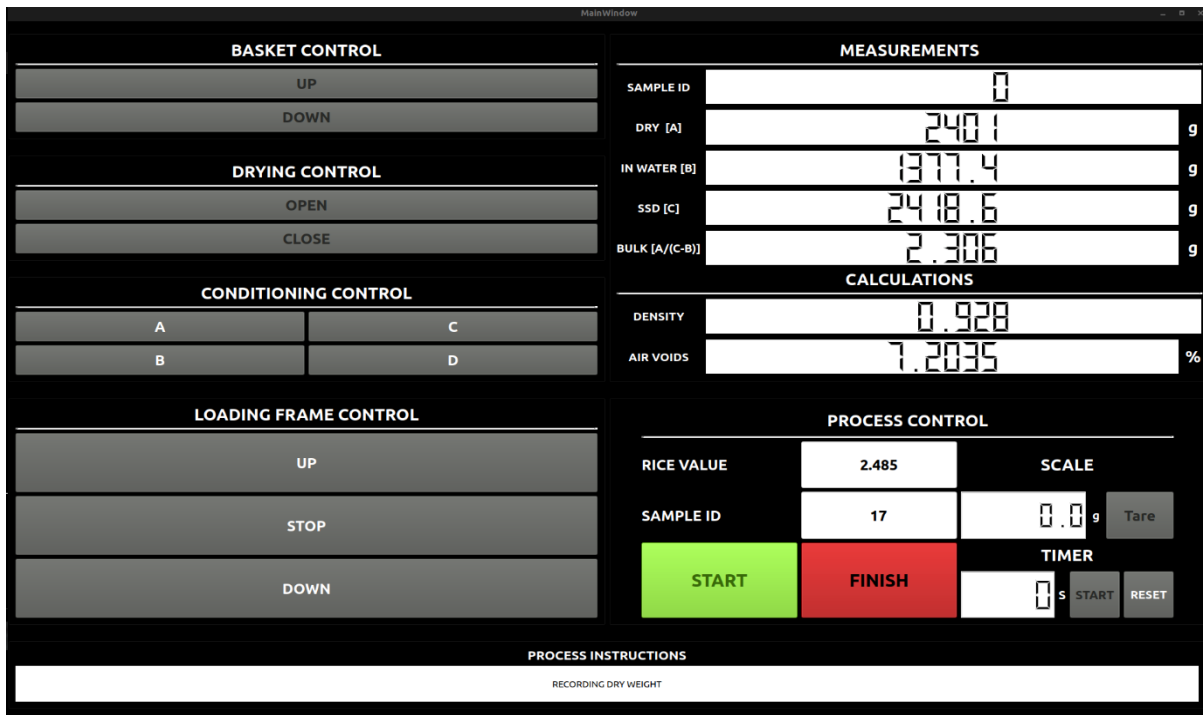
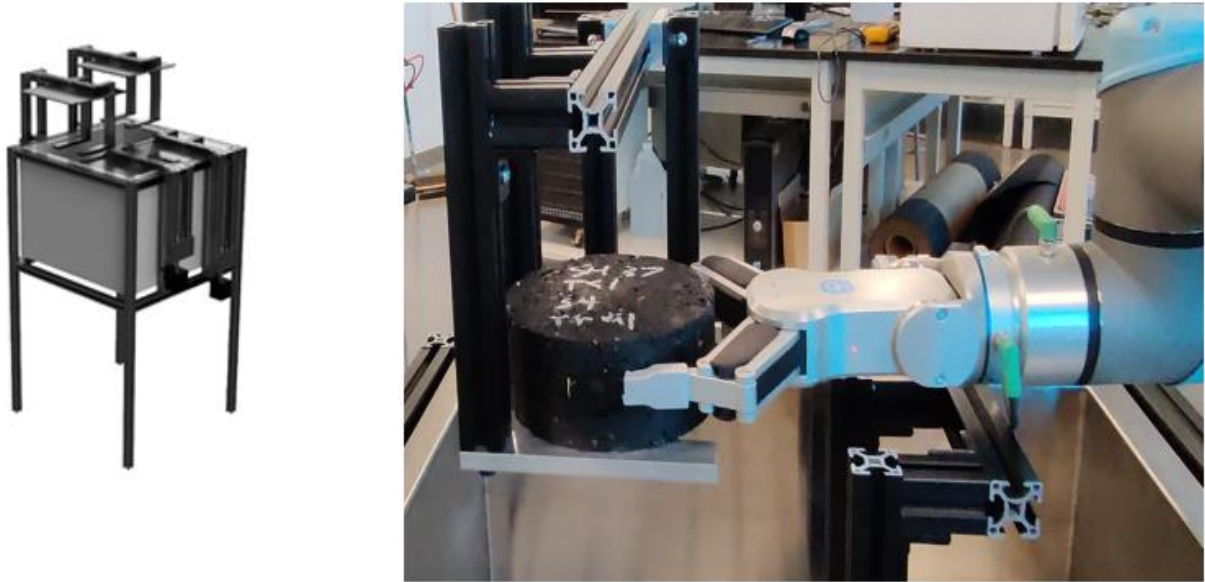


Figure 20. Computer Control Interface for Specimen Air Void Measurement.

### Actual Realization of Temperature Conditioning Unit

Based on the conceptual design of the final temperature conditioning shown in Figure 10, researchers purchased one temperature chamber for conditioning the specimens for IDEAL-CT or IDEAL-RT testing. To accomplish the automation process of conditioning specimens, researchers designed the automated lowering and lifting mechanism through linear actuators (Figure 21). The final temperature conditioning follows the air void measurement. The robot arm picks up the specimen from the scale and then places it on the lower rack into a water bath to condition the specimens before performing the IDEAL-CT or -RT testing. It took around

30 minutes for an IDEAL-CT specimen to reach the target temperature of 25°C and about 40 minutes for an IDEAL-RT specimen to reach the target temperature of 50°C.

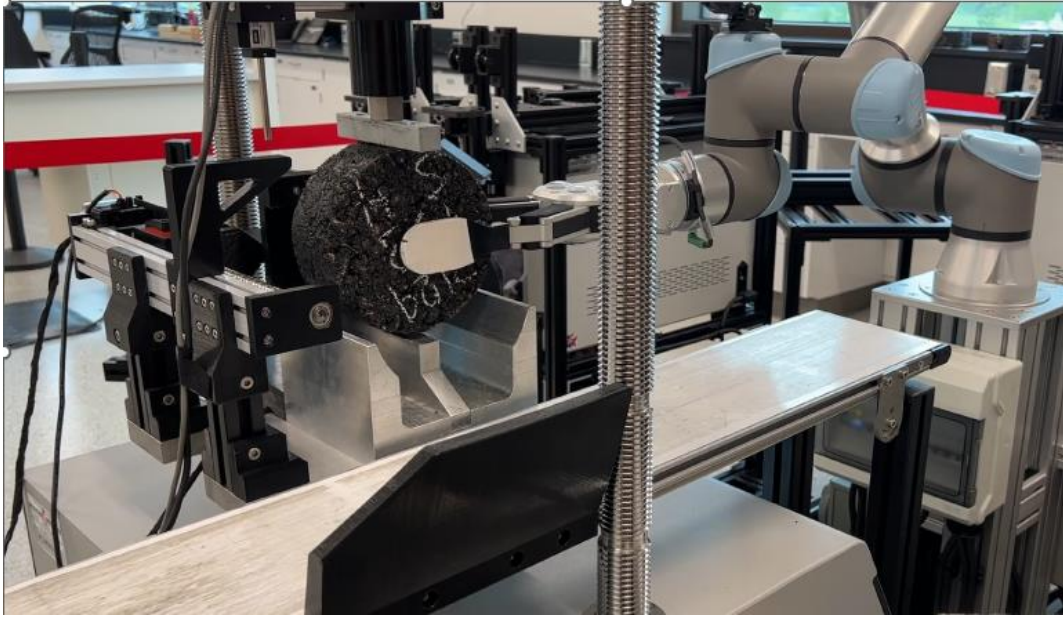


**Figure 21. Final Temperature Conditioning Unit.**

### **Actual Realization of Material Testing Unit**

Ideally, researchers would have designed and built a customized material testing machine. However, that was an unrealistic goal within the limited budget and time for this project. Therefore, the research team worked with one test equipment manufacturer to procure a suitable machine. The first obstacle researchers faced involved externally controlling the test machine to automatically perform the IDEAL-CT and IDEAL-RT testing. It took three months for both the research team and the test equipment manufacturer to realize that it was impossible to externally control the testing machine. Accordingly, researchers had to identify another test equipment manufacturer. Fortunately, the second equipment manufacturer was able to assist the research team with remotely controlling their machine. In the end, researchers could automatically control and perform both IDEAL-CT and IDEAL-RT testing (Figure 22).





**Figure 22. Final Material Testing Unit with a Conveyor Belt for Trashing Tested Specimen.**

#### **Actual Realization of Robotic Arm Unit**

The robot arm is a critical component of the whole AMAZE system. Researchers evaluated the robot arm market and decided to purchase the UR5e with a payload of 5 kg (Figure 23). The UR5e is an adaptable, collaborative industrial robot that tackles medium-duty applications with ultimate flexibility.



**Figure 23. Robotic Arm: UR5e.**

#### **Actual AMAZE Device**

After the completion of each individual unit, researchers assembled them together. Figure 24 shows the final version of the AMAZE device.



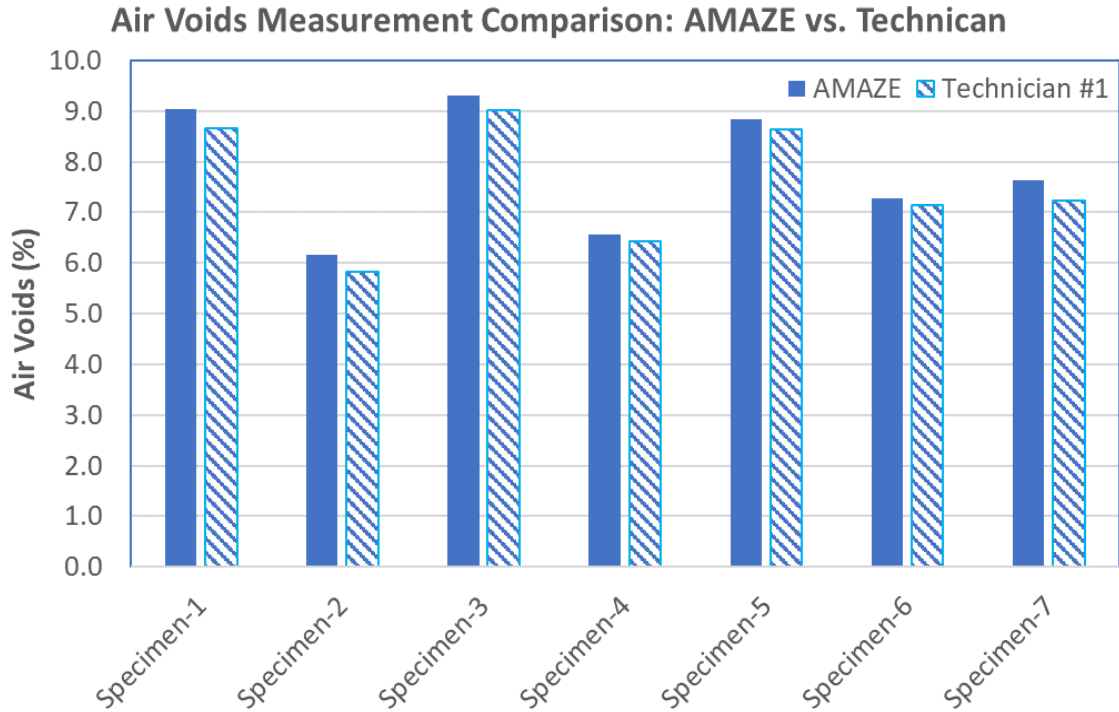
**Figure 24. AMAZE Device.**

## **EVALUATION OF THE COMPLETED AMAZE**

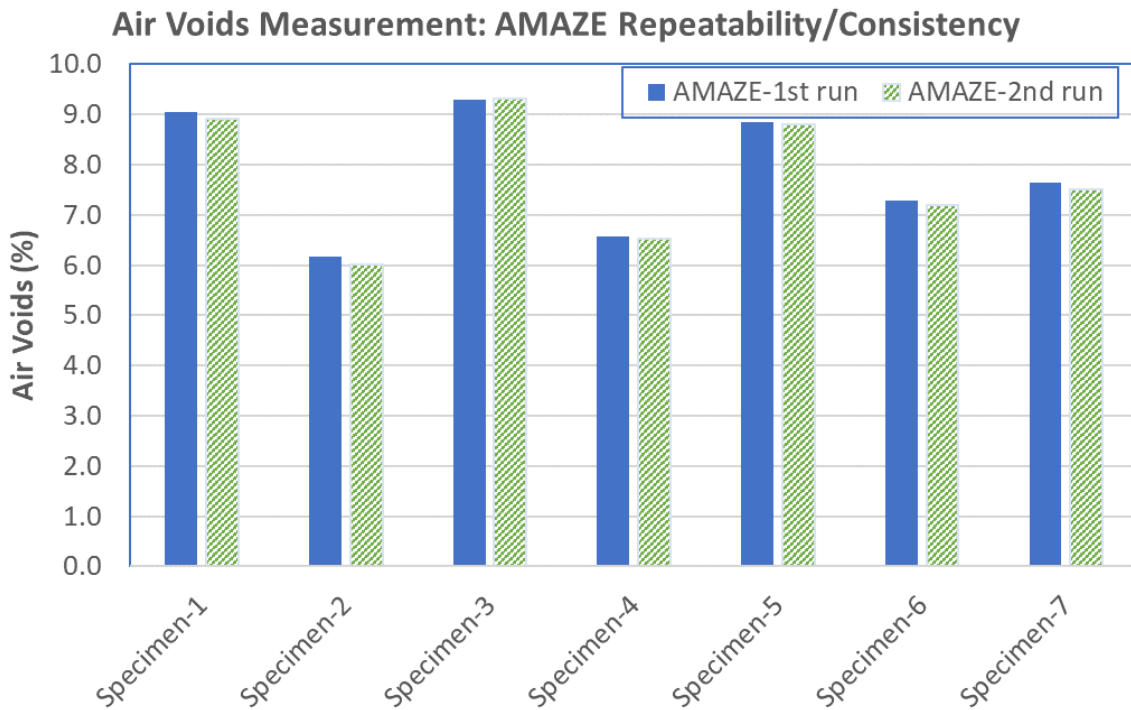
After successfully building AMAZE and ensuring its proper working condition, the research team compared the following measured asphalt mixture properties of various mixes: (a) air voids, (b)  $CT_{Index}$ , and (c)  $RT_{Index}$ . Figure 25 shows the air voids of seven specimens measured with AMAZE and with laboratory technician 1. The measured air void values are very close between the two. The maximum difference among the seven specimens is less than 0.5 percent, which is far less than the difference of 1.0 percent reported by Hand and Epps (2000) for lab technicians.

Furthermore, the research team investigated the repeatability of the AMAZE measurements. AMAZE measured the air voids of the seven specimens twice. Figure 26 presents the results. As seen in Figure 26, the air voids measured are almost identical between the first and second measurements of AMAZE. For comparison purposes, Figure 27 displays the air void measurements from two experienced lab technicians. AMAZE-measured air voids without human errors are objective and much more repeatable. Thus, AMAZE could be used as a referee for air void measurement, thereby allowing for any potential test result disputes between contractors and TxDOT to be minimized.

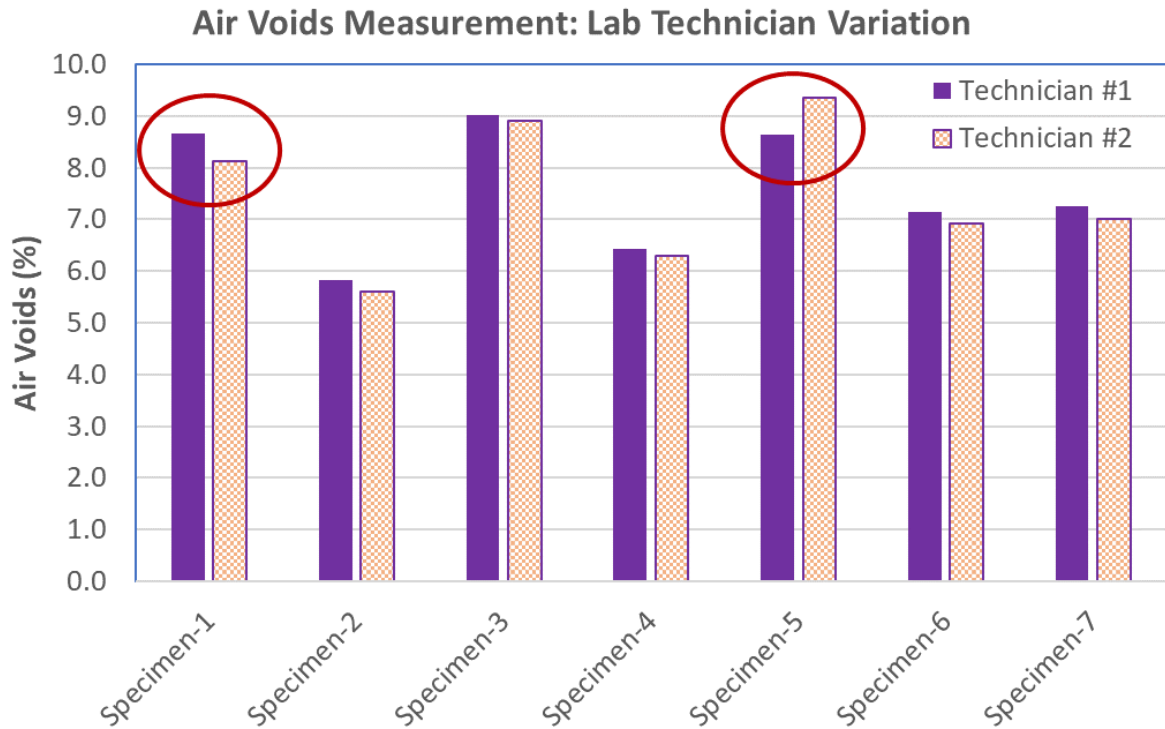
Also, researchers compared  $CT_{Index}$  values of three completely different mixtures: poor, better, and best cracking resistance. For each asphalt mixture, five replicates of specimens were tested. Figure 28 presents the IDEAL-CT results. Not only is the  $CT_{Index}$  average value for each mixture similar between AMAZE and the laboratory technician, the standard deviation of each mixture between AMAZE and the laboratory technician is also very close. Similar observations can be made for the IDEAL-RT test, as shown in Figure 29. Note that for the IDEAL-RT test, three replicates were conducted for each mixture.



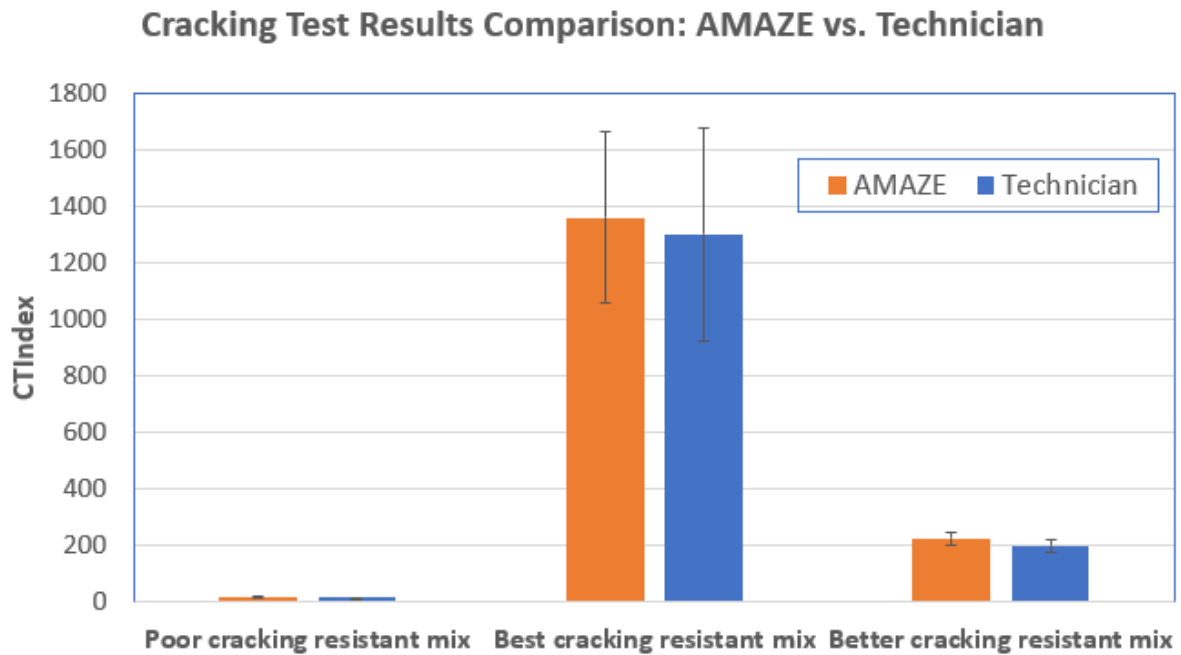
**Figure 25. Air Void Measurement Comparison.**



**Figure 26. Repeatability of Air Voids Measured by AMAZE.**

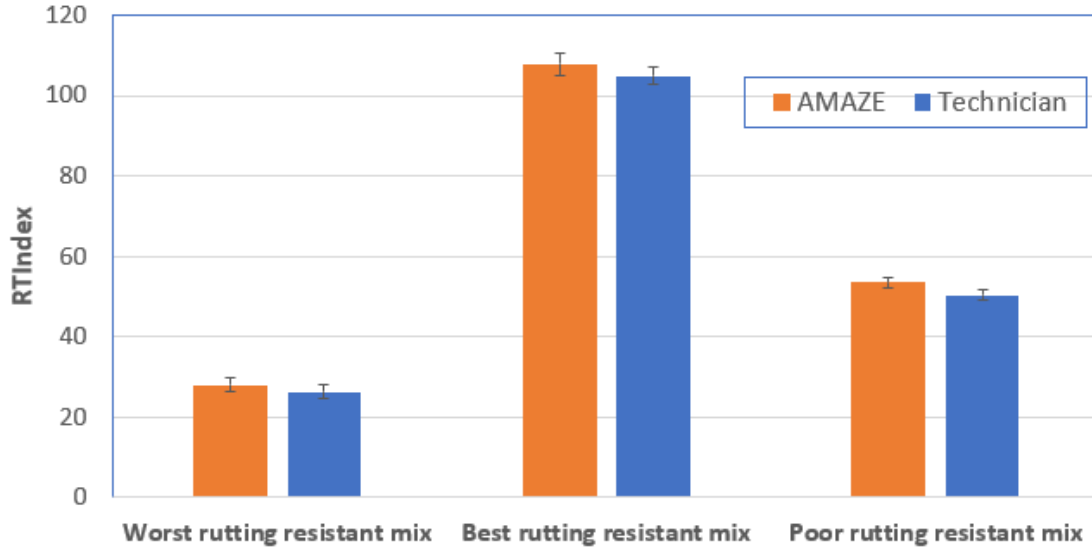


**Figure 27. Repeatability of Air Voids Measured by Two Experienced Lab Technicians.**



**Figure 28. IDEAL-CT Results Comparison.**

### Rutting Test Results Comparison: AMAZE vs. Technician



**Figure 29. IDEAL-RT Results Comparison.**

#### SUMMARY

The research team successfully constructed a working AMAZE. AMAZE is proven to be able to automatically perform three asphalt mixture tests: (a) bulk specific gravity test (or air voids), (b) ideal cracking test and IDT strength test, and (c) ideal rutting test.

AMAZE has very similar test results in terms of air voids,  $CT_{Index}$ , and  $RT_{Index}$  when compared to those measured by laboratory technicians. However, results from AMAZE with a robotic arm have much better repeatability and consistency than those of laboratory technicians.



## CHAPTER 5. AMAZE IMPLEMENTATION PLAN

AMAZE is a cutting-edge device for improving mix durability, lab work productivity, and test result consistency. Just like any new product, it takes effort and time to implement AMAZE. For example, it took around 20 years for departments of transportation (DOTs) to fully implement the Superpave binder and mixture design specifications. The envisioned steps in the implementation plan for the AMAZE device include the following:

- Undertake shadow projects: A good practice for implementing a new device is through a series of shadow projects. Completing a few shadow projects with the new AMAZE device for information only would help work out sampling and testing logistics for contractors and DOTs, as well as assess how results compare to those of the laboratory technicians. Shadow projects often facilitate early buy-in, which is an essential step in any implementation effort. The research team has discussed collaboration with TxDOT and Virginia DOT for a few shadow projects, and both DOTs are interested.
- Purchase more AMAZE devices: Availability of the AMAZE device is critical for implementation. TxDOT may purchase a few more AMAZE devices for regional labs.
- Form a TxDOT–asphalt industry working group: To implement anything new or make changes, it is crucial to get every party involved in the process as early as possible so that all stakeholders are aware of and prepared for what is coming. One way to do this is to establish a TxDOT–asphalt industry working group through the Texas Asphalt Pavement Association (TxAPA). Regional quality group meetings are another effective way to disseminate the research findings from this critical project.
- Implement pilot projects: A further step of implementation is pilot projects. Unlike shadow projects, where testing is for information only, pilot projects use the test results to approve and accept asphalt mixtures. Generally, the pilot projects start on a small scale, such as just a few in the first year, then one to two projects in most districts in the second year, and so on. Adjustments may be necessary to each round based on the information and lessons learned. The pilot projects would enable more stakeholders to become more familiar with the new AMAZE device and how its results could influence mix design and production acceptance. TexasBit (an asphalt mix producer and construction company) is interested in using the AMAZE device in a few pilot projects for production quality control.
- Develop flyers and videos: Two one-page flyers along with videos could be developed to disseminate the information. One flyer for TxDOT senior management could describe the benefits and the cost implications. A second flyer could be developed for TxDOT bituminous engineers, hot-mix specialists, consultants, and the asphalt industry with more technical information on test setup and a step-by-step test process. Short, high-definition, professionally produced videos could accompany the flyers.
- Provide training and certification: Training engineers and technicians on the use of the AMAZE device is vital to successful implementation. TxDOT also needs to coordinate with TxAPA to get QC personnel trained.
- Proceed with statewide implementation: Full implementation should occur after pilot projects in every district and stakeholder buy-in are complete. It may take 3–5 years or longer to successfully implement a new cracking or other test.





## CHAPTER 6. CONCLUSION AND RECOMMENDATIONS

### CONCLUSION

This innovative research developed a robot-based device, AMAZE, which has four units: (a) an air void measurement unit, (b) temperature conditioning units (one for IDEAL-CT and one for IDEAL-RT), (c) a material testing unit, and (d) a robot arm. During this research project, automation was achieved with a robot arm for air void measurement, temperature conditioning, and cracking and rutting testing.

The AMAZE test results for air voids,  $CT_{Index}$ , and  $RT_{Index}$  are very similar to those measured by laboratory technicians. However, the results from AMAZE with a robotic arm have much better repeatability and consistency than those of laboratory technicians.

### RECOMMENDATIONS

Based on the results of this study, the researchers recommend the following:

- Implement the AMAZE device following the developed implementation plan. AMAZE implementation will allow TxDOT and asphalt industry professionals to (a) produce high-quality asphalt mixes with long-lasting life, (b) remedy the loss of the workforce and the skills associated with the retired workforce, and (c) improve test consistency and the safety of the working environment.
- Develop automated lab tests for asphalt binders (such as the dynamic shear rheometer test and asphalt binder specific gravity measurement) followed by gyratory mixing and molding, sawing, HWTT, and others.



## REFERENCES

- Brown, E. R., and S. A. Cross (1992). “A National Study of Rutting in Hot-Mix Asphalt (HMA) Pavements,” *Journal of Annual Meeting of the Association of Asphalt Paving Technologists*, Vol. 61, pp. 535–580.
- Christensen, D., and R. Bonaquist (2002). “Use of Strength Tests for Evaluating the Rut Resistance of Asphalt Concrete,” *Journal of the Association of Asphalt Paving Technologists*, Vol. 71, pp. 692–711.
- Hand, A., and J. Epps (2000). “Effects of Test Variability on Mixture Volumetrics and Mix Design Verification,” *Journal of Association of Asphalt Paving Technologists*, Vol. 69, pp. 635–674.
- Kandray, D. E. (2010). *Programmable Automation Technologies*, Industrial Press.
- Pande, O., and L. Holpp (2002). *What Is Six Sigma*, McGraw-Hill.
- Tapping, D., ed. (2010). *The New Lean Pocket Guide XL*, MCS Media.
- Walby, T. (2015). “Why Bill Gates Was Wrong on Automation,” <https://cloud.blueprism.com/why-i-disagree-with-bill-gates>. Accessed July 21, 2020.
- West, R. (2019). “The IDEAL Cracking Test,” presentation at 2019 NRRA Workshop. <https://www.dot.state.mn.us/mnroad/nrra/pavementconference/index.html>. Accessed July 21, 2020.
- Zhou, F., S. Im, L. Sun, and T. Scullion (2017). “Development of an IDEAL Cracking Test for Asphalt Mixture Design, Quality Control and Quality Assurance,” *Journal of Association of Asphalt Paving Technologists*, Vol. 18, 2017, pp. 405–427.
- Zhou, F., W. Crockford, J. Zhang, et al. (2019). “Development of an IDEAL Rutting Test for Asphalt Mixture Design, Quality Control and Quality Assurance,” *Journal of Association of Asphalt Paving Technologists*, Vol. 88, pp. 458–496.

